

Date	rev.	Description	Sheet
------	------	-------------	-------

		House P6038-70 Adela	1
--	--	----------------------	---

		Drawing 3D	Scale
--	--	------------	-------

		Material 70x135	Date 15.02.2016
--	--	-----------------	-----------------

		Drawer RP	File P6038-70 Adela 3D.dwg
--	--	-----------	----------------------------

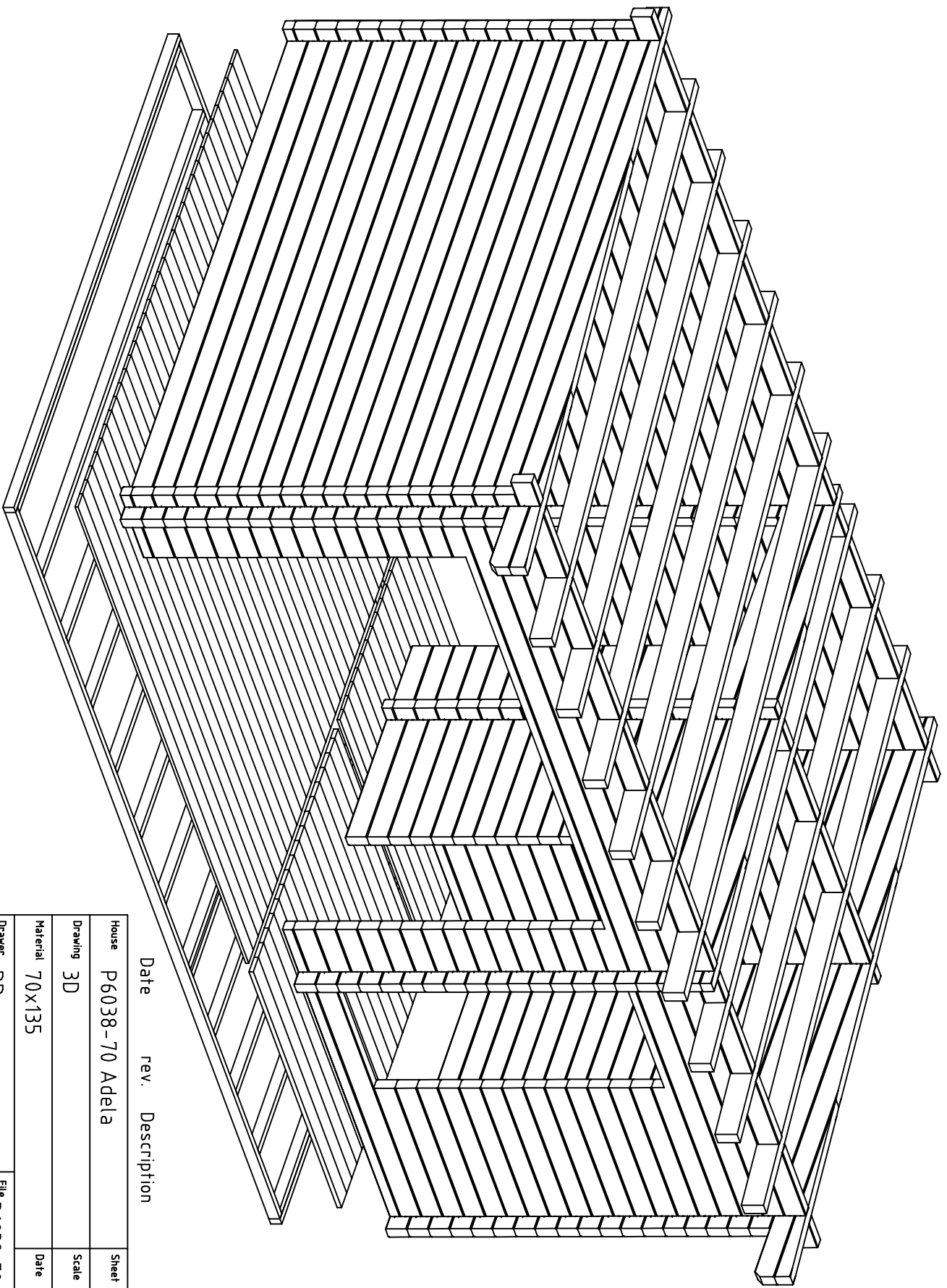

Date	rev.	Description	Sheet
------	------	-------------	-------

		House P6038-70 Adela	2
--	--	----------------------	---

		Drawing 3D	Scale
--	--	------------	-------

		Material 70x135	Date 15.02.2016
--	--	-----------------	-----------------

		Drawer RP	File P6038-70 Adela 3D.dwg
--	--	-----------	----------------------------

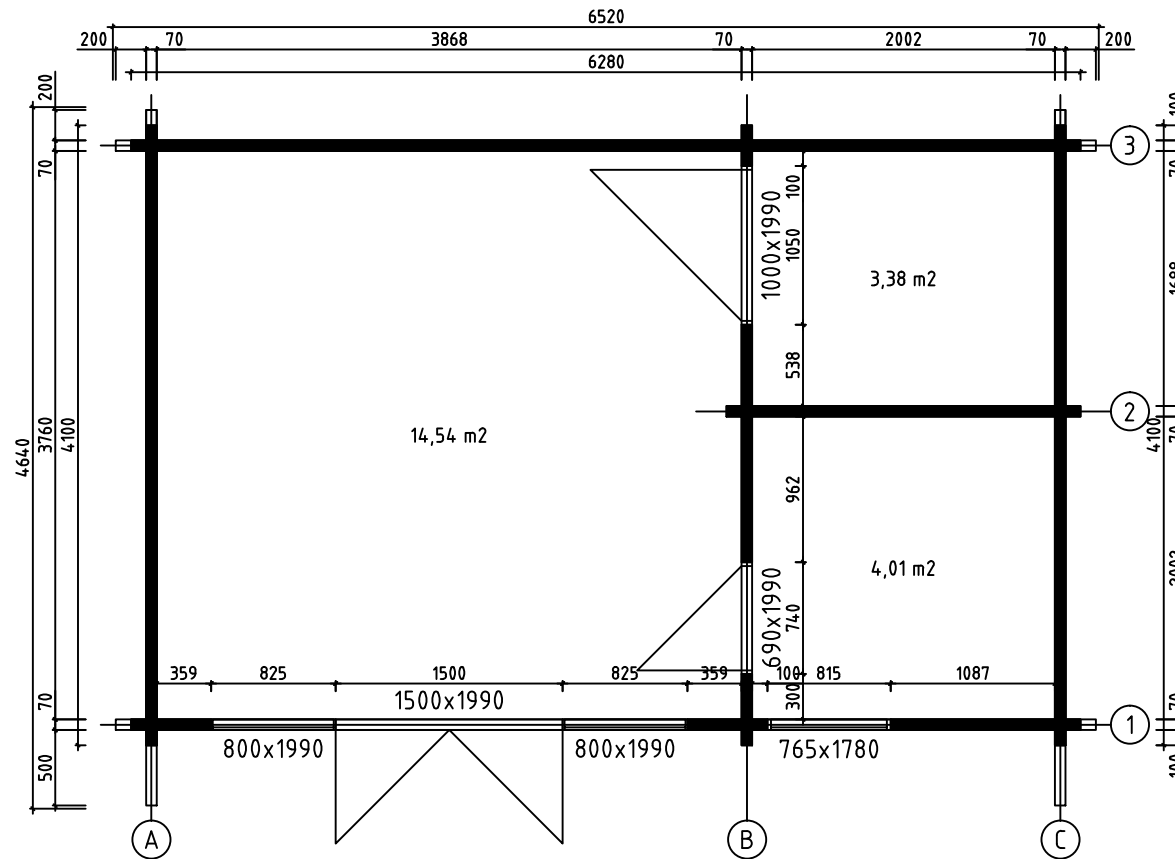

House	P6038-70 Adela	Sheet	3
Drawing	PLAN-SUUNNITELMA-PLANEN	Scale	1:50
Material	70x135	Date	15.02.2016
Drawer	RP	File	P6038-70 Adela.dwg

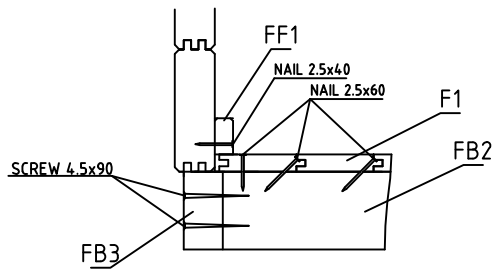
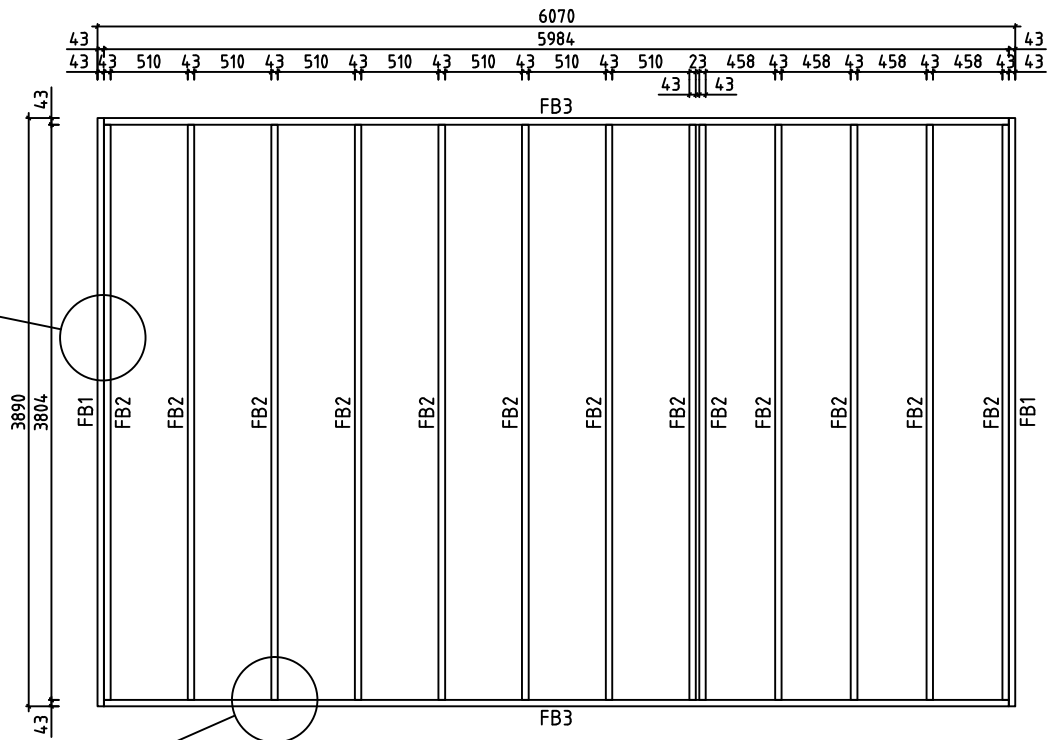
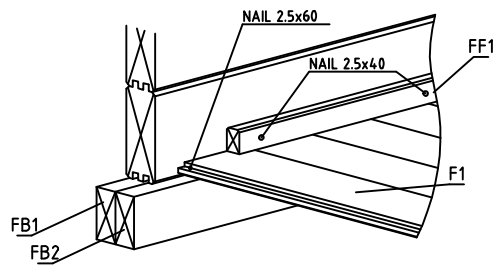

House	P6038-70 Adela	Sheet	4
Drawing	FLOORBEAMS-LATTIAPALKIT-GOLVBJÄLKAR	Scale	1:50
Material	43x70	Date	15.02.2016
Drawer	RP	File	P6038-70 Adela.dwg

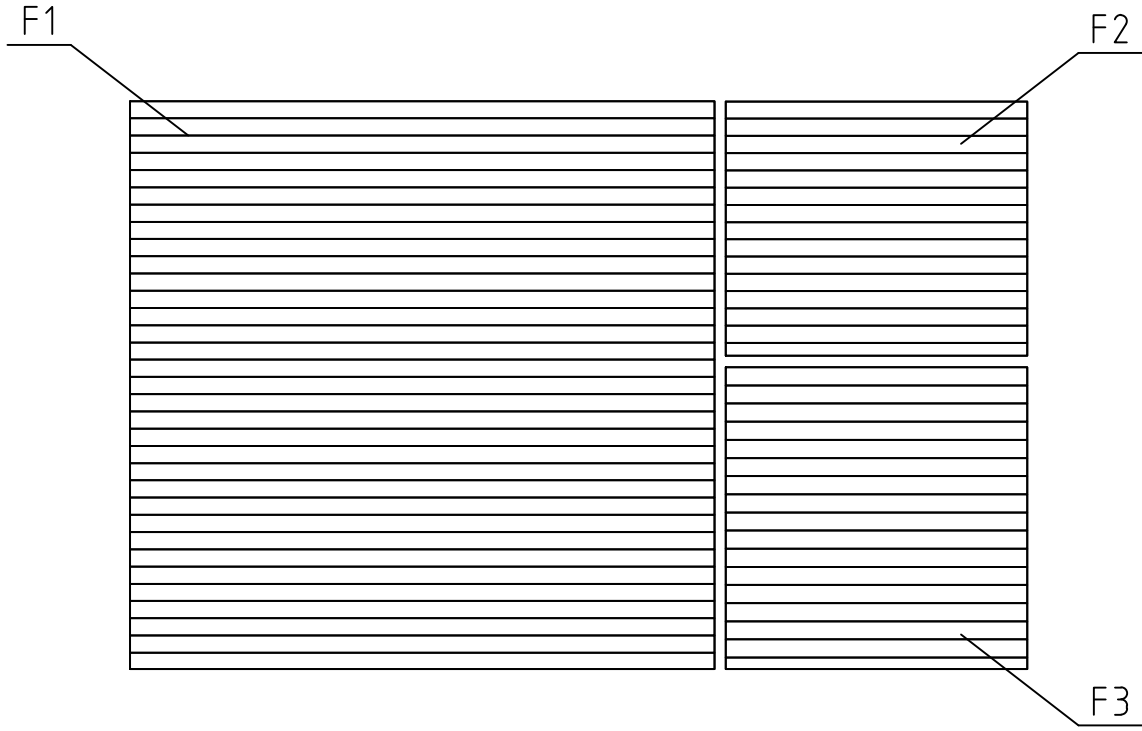

House	P6038-70 Adela	Sheet	5
Drawing	FLOORBOARD-LATTIALAUTA-GOLVBRÄDE	Scale	1:50
Material	114x19, 120x28	Date	15.02.2016
Drawer	RP	File	P6038-70 Adela.dwg

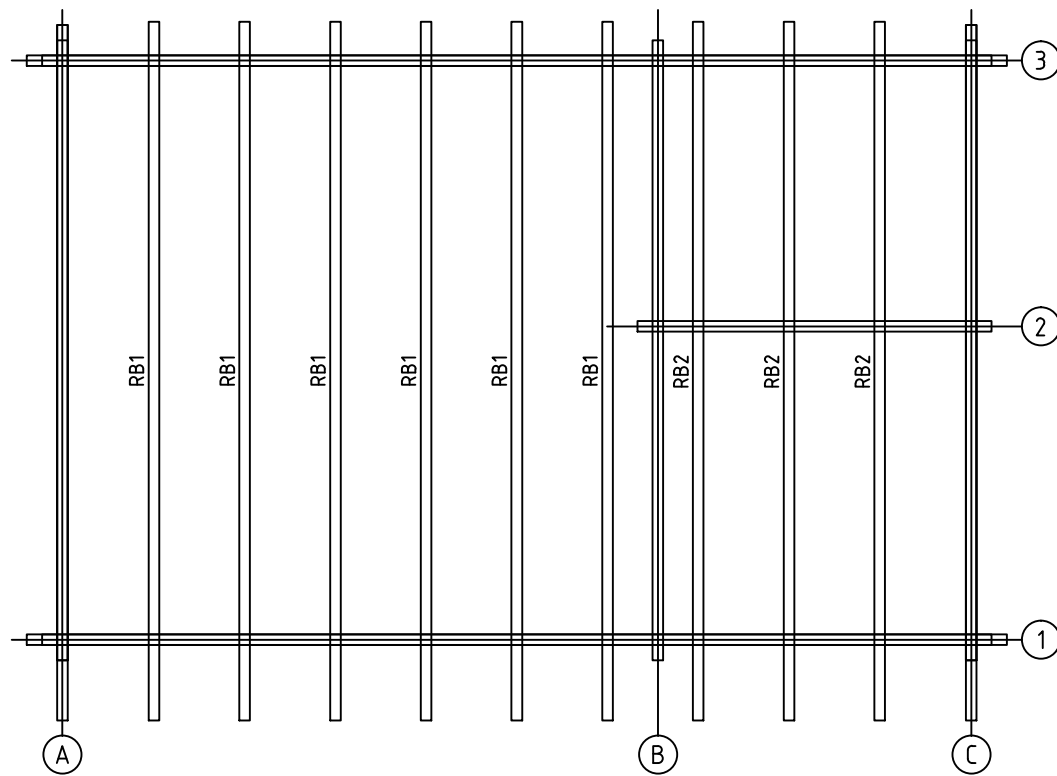

House	P6038-70 Adela	Sheet	6
Drawing	PURLINS-KATTO-ORRET-TAKÅSAR	Scale	1:50
Material	70x140	Date	15.02.2016
Drawer	RP	File	P6038-70 Adela.dwg

R1

R2

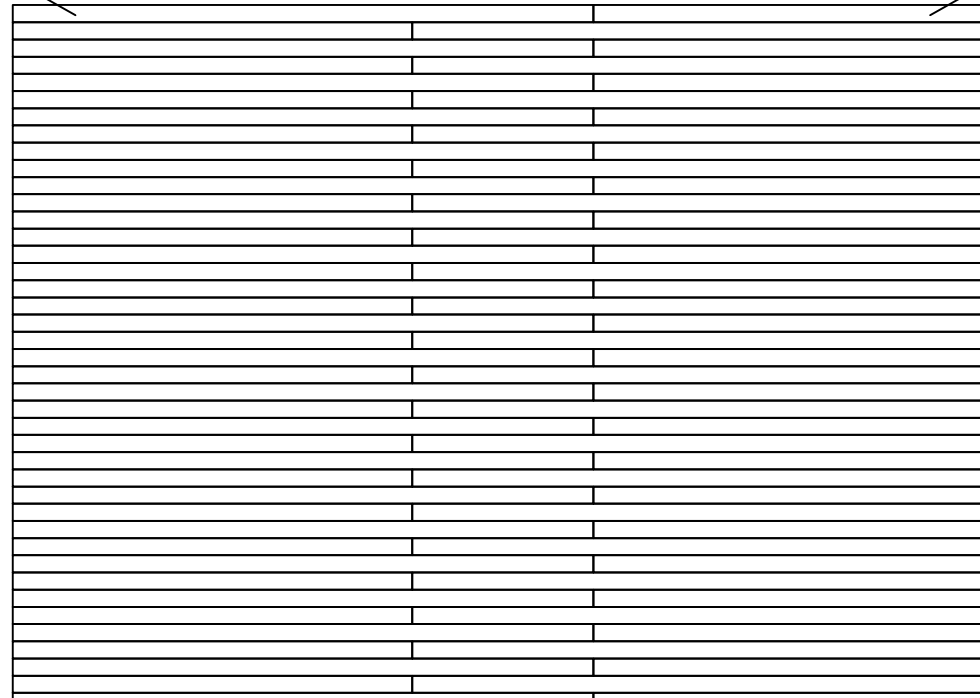

House	P6038-70 Adela	Sheet	7
Drawing	ROOFBOARD - KATTOLAUTA - TAKBRÄDE	Scale	1:50
Material	114x19	Date	15.02.2016
Drawer	RP	File	P6038-70 Adela.dwg

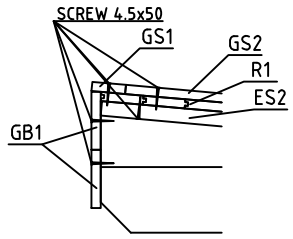

Wall-Seinä-Vägg A ↗

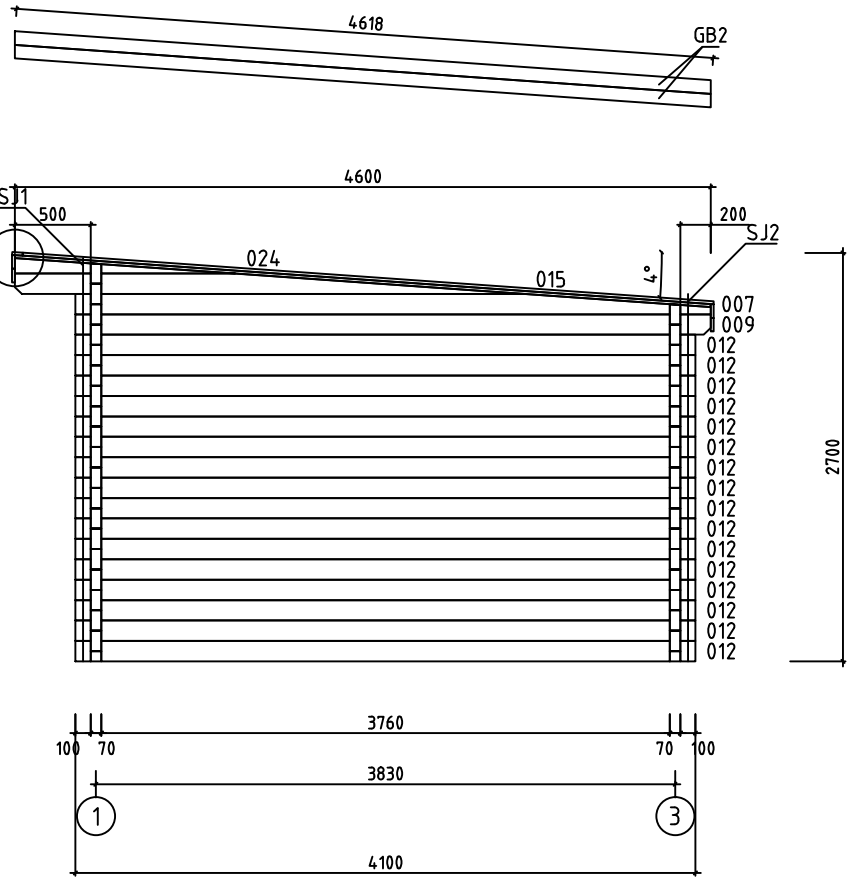

House	P6038-70 Adela	Sheet	8
Drawing	WALL-SEINÄ-VÄGG A	Scale	1:50
Material	70x135	Date	15.02.2016
Drawer	RP	File	P6038-70 Adela.dwg

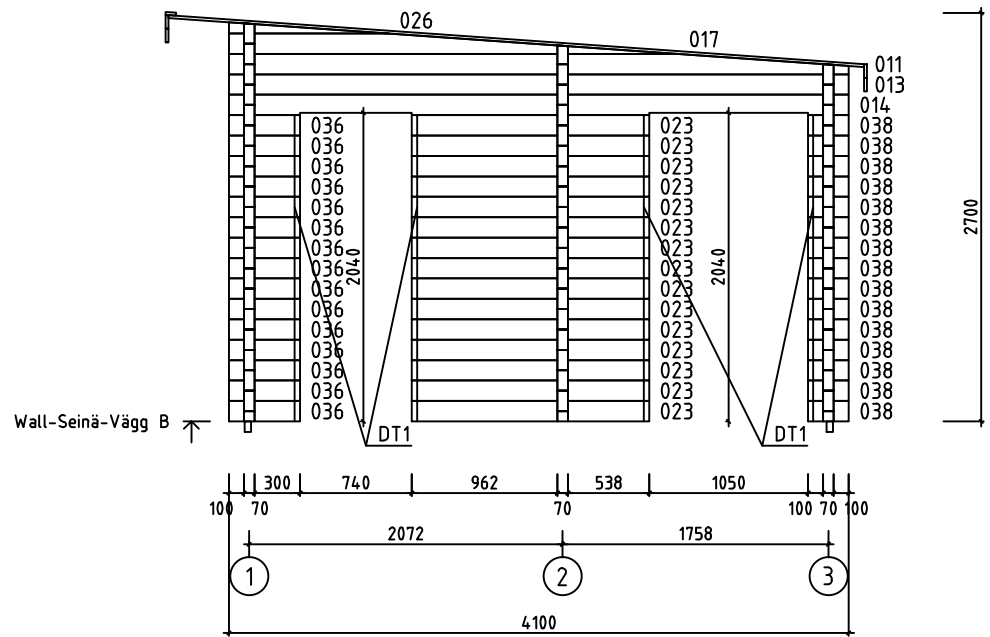

House	P6038-70 Adela	Sheet	9
Drawing	WALL-SEINÄ-VÄGG B	Scale	1:50
Material	70x135	Date	15.02.2016
Drawer	RP	File	P6038-70 Adela.dwg

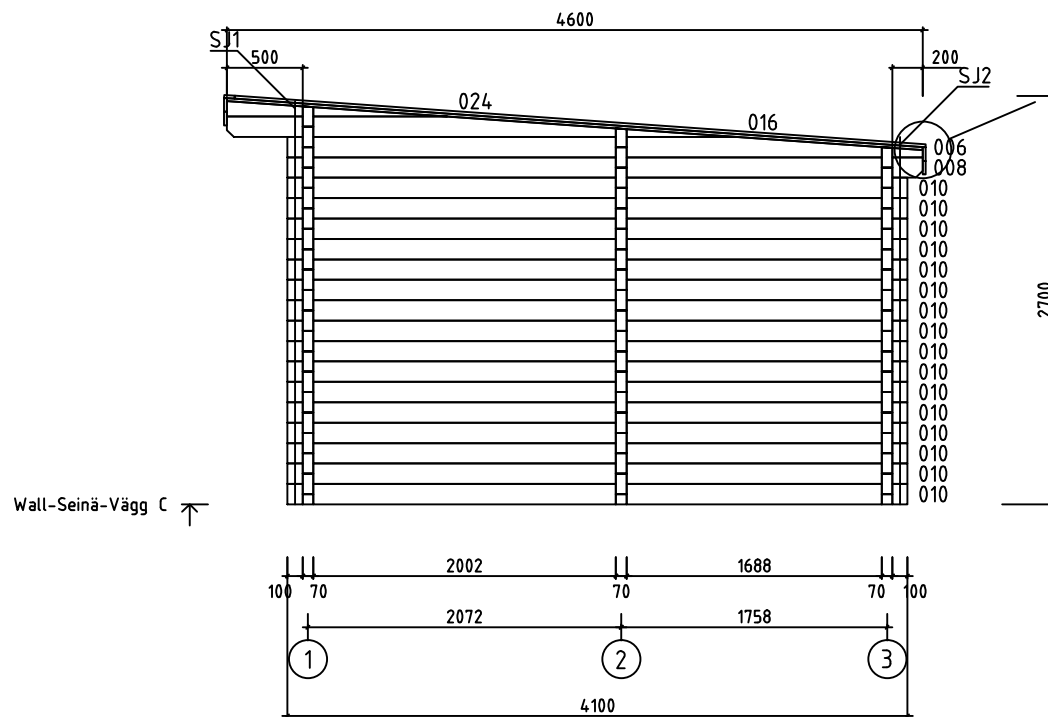
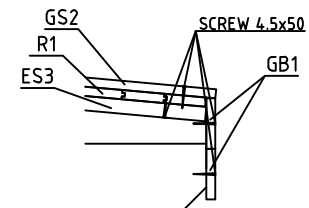

House	P6038-70 Adela	Sheet	10
Drawing	WALL-SEINÄ-VÄGG C	Scale	1:50
Material	70x135	Date	15.02.2016
Drawer	RP	File	P6038-70 Adela.dwg

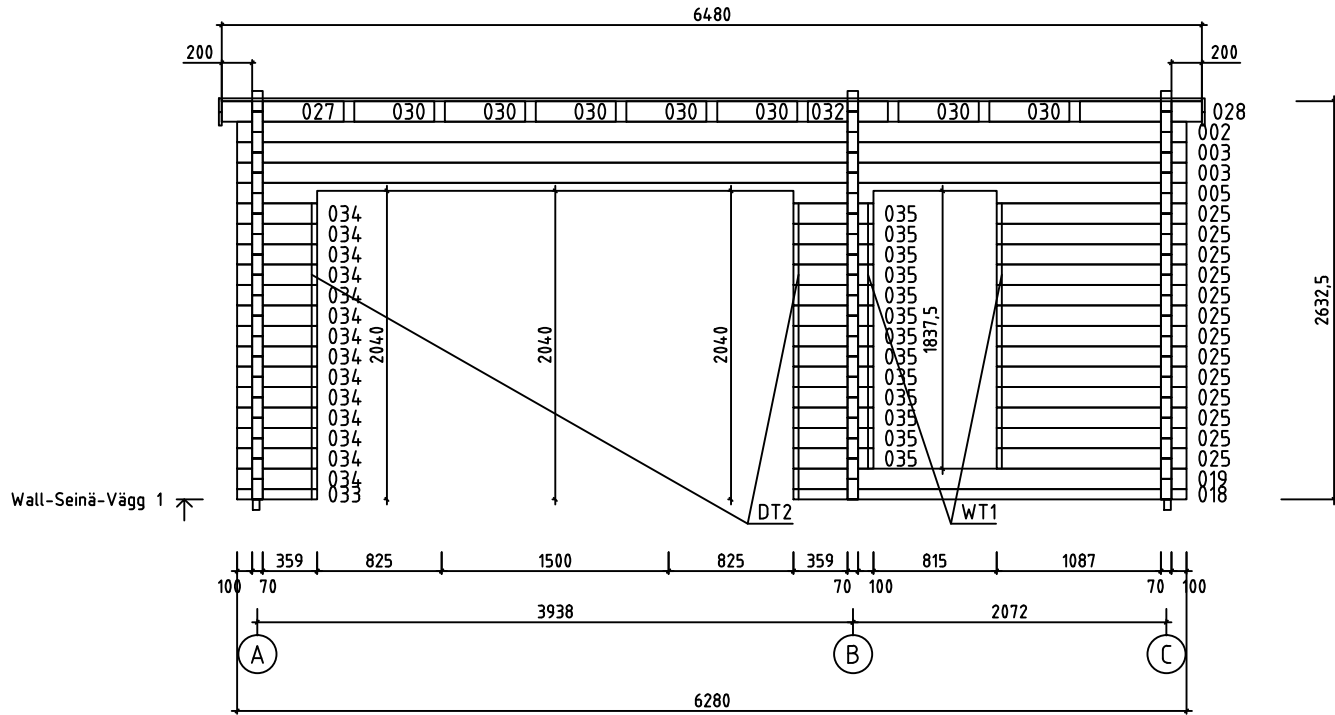
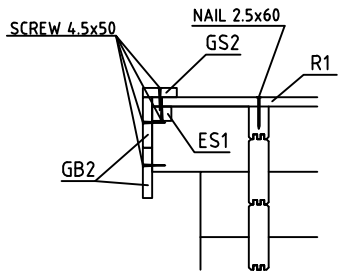

House	P6038-70 Adela	Sheet	11
Drawing	WALL-SEINÄ-VÄGG 1	Scale	1:50
Material	70x135	Date	15.02.2016
Drawer	RP	File	P6038-70 Adela.dwg

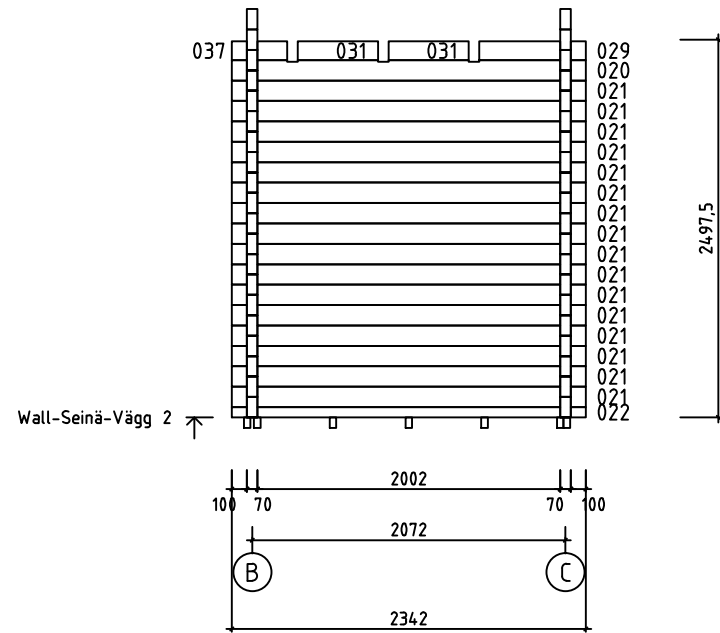



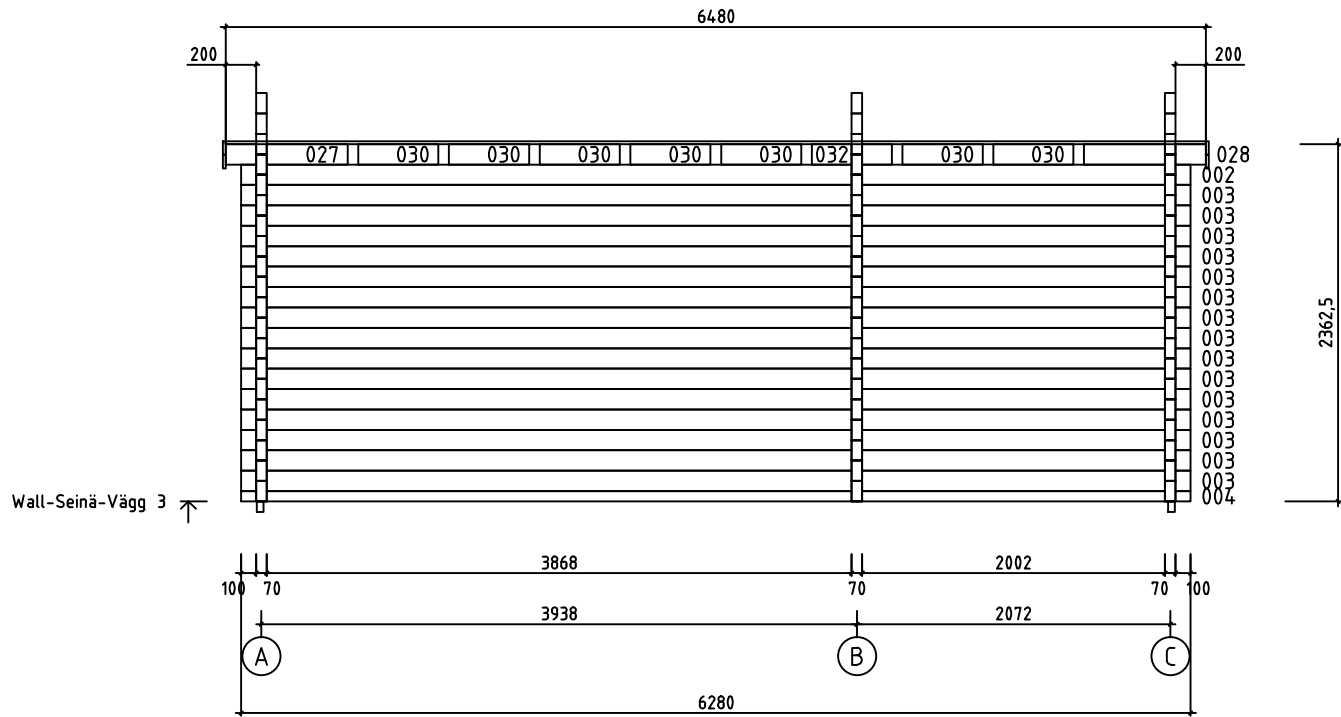













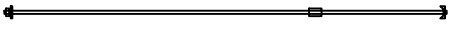

House	P6038-70 Adela	Sheet	12
Drawing	WALL-SEINÄ-VÄGG 2	Scale	1:50
Material	70x135	Date	15.02.2016
Drawer	RP	File	P6038-70 Adela.dwg

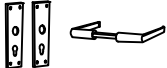

House	P6038-70 Adela	Sheet	13
Drawing	WALL-SEINÄ-VÄGG 3	Scale	1:50
Material	70x135	Date	15.02.2016
Drawer	RP	File	P6038-70 Adela.dwg

Pos	P6038-70 Adela	Pcs. St.	Profil(e) (mm)	L (mm)
001	SPARE BEAM - VARALLAPALKI - RESERVDEL 100 3868 2002 100	1	70x135	6280
002	100 3868 2002 100 PM	2	70x135	6280
003	100 3868 2002 100	17	70x135	6280
004	100 3868 2002 100	1	70x68	6280
005	100 3868 2002 100	1	70x135	6280
008	100 2002 1688 200	1	70x135	4200
009	100 3760 200	1	70x135	4200
010	100 2002 1688 100	16	70x135	4100
012	100 3760 100	16	70x135	4100
013	100 2002 1688 100	1	70x135	4100
014	100 2002 1688 100	1	70x135	4100
018	359 2002 100	1	70x68	2601
019	359 2002 100	1	70x135	2601
020	100 2002 100	1	70x135	2342
021	100 2002 100	16	70x135	2342
022	100 2002 100	1	70x68	2342
023	962 538	15	70x135	1570
025	1087 100	13	70x135	1257
027	200 535	2	70x135	805
028	535 200	2	70x135	805
029	535 100	1	70x124	705
030		14	70x135	530
031		2	70x124	530
032	263 197	2	70x135	530
033	100 359	1	70x68	529
House P6038-70 Adela		Material	File P6038-70 Adela.dwg	Sheet 14

Pos	P6038-70 Adela		Pcs. St.	Profil(e) (mm)	L (mm)
034			14	70x135	529
035			13	70x135	529
036			15	70x135	470
037			1	70x124	367
038			15	70x135	270
WA-1			1	70x373	4600
WB-1			1	70x345	4100
WC-1			1	70x373	4600
HB	HIT BLOCK-ASENNUSPALKI-SLAG BRÄDA		2	70x135	300
FB3	FLOORBEAMS - LATTIAPALKIT - GOLVBJÄLKAR		2	43x70	5984
FB1	FLOORBEAMS - LATTIAPALKIT - GOLVBJÄLKAR		2	43x70	3890
FB2	FLOORBEAMS - LATTIAPALKIT - GOLVBJÄLKAR		13	43x70	3804
RB1	PURLINS - KATTO - ORRET - TAKASAR		6	70x140	4622
RB2	PURLINS - KATTO - ORRET - TAKASAR		3	70x140	4622
F1	FLOORBOARD - LATTIALAUTA - GOLVBRÄDE		33+1 43+1	114x19 88x19	3865
F2	FLOORBOARD - LATTIALAUTA - GOLVBRÄDE		15+1 20+1	114x19 88x19	1995
F3	FLOORBOARD - LATTIALAUTA - GOLVBRÄDE		17+1	120x28	1995
R1	LOFT BOARD - PARVIALATTIA - LOFTGOLV		41+1 54+1	114x19 88x19	3840
R2	ROOFBOARD - KATTOLAUTA - TAKBRÄDE		41+1 54+1	114x19 88x19	2640
FF1	SKIRTING SLAT - LATTIALISTA - GOLVLIST			19x35	32 m
GB1	GABLE BOARD - KAAPELILAUTA - GAVELBRÄDA		8	19x90	3260
GB2	GABLE BOARD - KAAPELILAUTA - GAVELBRÄDA		4	19x90	4618
House	P6038-70 Adela	Material	File	P6038-70 Adela.dwg	Sheet 15

Pos	P6038-70 Adela		Pcs. St.	Profil(e) (mm)	L (mm)	
GS1	BOARD MATCHING WITH GABLE BOARD-KAAPELILAUTA VASTAVA LAUTA-BRÄDA OVANPÅ GAVELBRÄDA		2	19x70	3260	
GS2	BOARD MATCHING WITH GABLE BOARD-KAAPELILAUTA VASTAVA LAUTA-BRÄDA OVANPÅ GAVELBRÄDA		2	19x70	4580	
ES1	EAVE SLAT - RÄYSTÄSLISTA - TAKFOTLIST		2	30x40	3770	
ES2	EAVE SLAT - RÄYSTÄSLISTA - TAKFOTLIST		2	30x40	500	
ES3	EAVE SLAT - RÄYSTÄSLISTA - TAKFOTLIST		2	30x40	200	
DT1	DOOR ASSEMBLING PROFILE-OVEN ASENNUSPROFIILI -DÖRR MONTERINGSPROFIL		4	43x70	1990	
DT2	DOOR ASSEMBLING PROFILE-OVEN ASENNUSPROFIILI -DÖRR MONTERINGSPROFIL		2	43x70	1920	
WT1	WINDOW ASSEMBLING PROFILE-IKKUNA ASENNUSPROFIILI -FÖNSTER MONTERINGSPROFIL		2	43x70	1720	
SJ1	SCREW JOINT-KIERRETANKO-GÄNGSTAPP		2	∅M10	2670	
SJ2	SCREW JOINT-KIERRETANKO-GÄNGSTAPP		2	∅M10	2380	
	NAILS-NAULAT-SPIKAR FOR-VARTEN-FÖR	FF1		70	∅2.0	40
	NAILS-NAULAT-SPIKAR FOR-VARTEN-FÖR	F1, F2, F3, R1, R2		1240	∅2.5	60
	SCREWS-RUUVIT-SKRUVAR FOR-VARTEN-FÖR	GB1, GB2, GS1, GS2, ES1, ES2, ES3		120	∅4.5	50
	SCREWS-RUUVIT-SKRUVAR FOR-VARTEN-FÖR	004, 018, 022, 033 FB1, FB2, FB3		80	∅4.5	90
	SCREWS-RUUVIT-SKRUVAR FOR-VARTEN-FÖR	027, 028, 029, 030, 031, 032, 037 RB1, RB2		70	∅6.0	160
	DOOR HANDLE-OVEN KAHVA-DÖRR HANDTAG FOR-VARTEN-FÖR	D1, D2		2		
	DOOR LOCK+KEYS-OVENLUKKO+AVAIN-DÖRRLAS+NYCKLAR FOR-VARTEN-FÖR	D1, D2		2		
	DOOR HANDLE-OVEN KAHVA-DÖRR HANDTAG FOR-VARTEN-FÖR	D3		1		
	DOUBLEDOOR FRAME SET FOR-VARTEN-FÖR	D1		1		
House	P6038-70 Adela	Material	File	P6038-70 Adela.dwg	Sheet	16

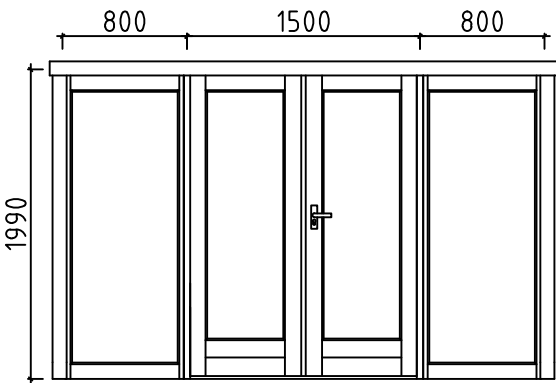
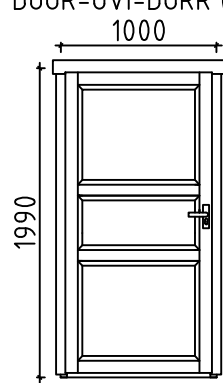
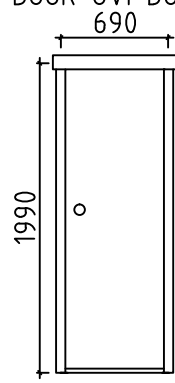
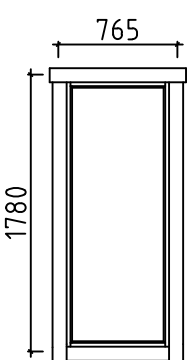
Pos	P6038-70 Adela	Pcs. St.	Profil(e) (mm)	L (mm)
D1 W1	DOOR-OVI-DÖRR (right-oikea-höger) ORT_ST 	P 1 2	1500 800	1990 1990
D2	DOOR-OVI-DÖRR (left-jäljellä-vänster) AST 	V 1	1000	1990
D3	DOOR-OVI-DÖRR (right-oikea-höger) 	P 1	690	1990
W1	WINDOW-IKKUNAN-FÖNSTER ORT_ST_K 	1	765	1780
House P6038-70 Adela		Material	File P6038-70 Adela.dwg	Sheet 17

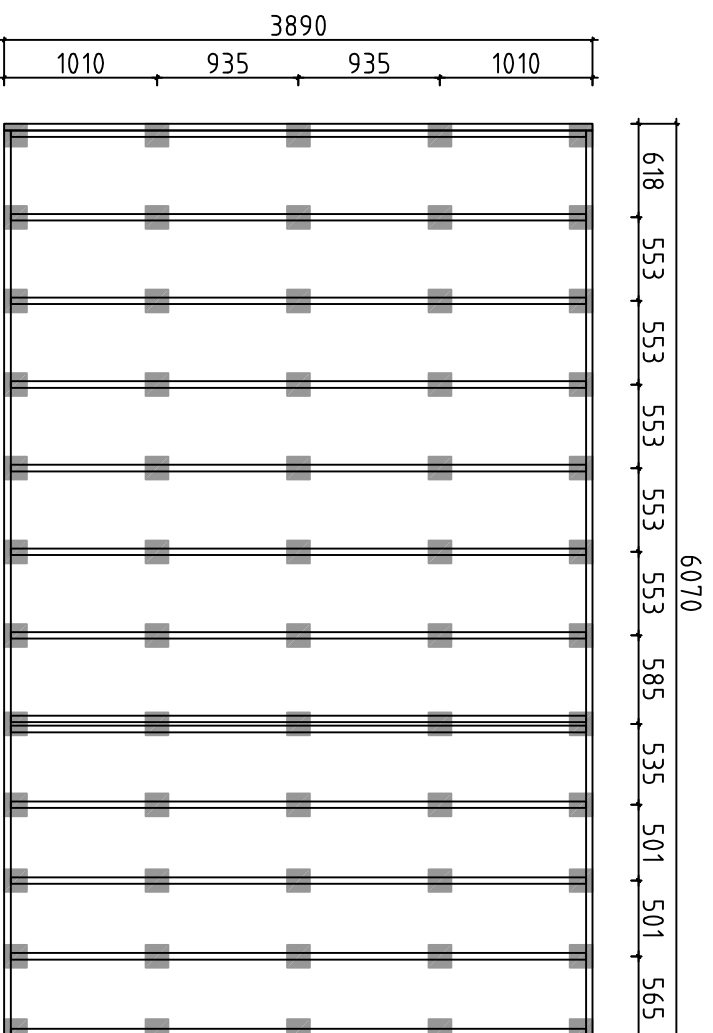

Detta är ett förslag för hur man kan placera plintarna (100-200 mm i diameter) för golvbjälklaget. Golvbjälkarna är med i byggsatsen, men inte plintarna. Använder man exempelvis 500-600mm långa murblock så kan man halvera antalet punkter. Lägg fuktskyddande papp mellan betong och trä

Tämnä on ehdotus siitä, miten (100-200 mm läpimitäiset) jalat voidaan sijoittaa alapohjaa varten. Lattiapalkit ovat rakennussarjassa, mutta jalat ei ole. Kun käytetään esimerkiksi 500-600 mm pitkiä harkkoja, voidaan pisteiden määrä puoltaa. Aseta betonin ja puun väliin kosteudelta suojaava pähvi

A proposal for placing plinths (100-200 mm in diameter) for floor beams. Floor beams are provided in the kit but plinths are not included. For example, by using 500-600 mm long masonry units, one can reduce the number of points 50%. Place cardboard between the concrete and wood to protect from moisture

House	P6038-70 Adela	Sheet	18
Drawing	FOUNDATION PLAN - PLINTPLAN	Scale	1:50
Material		Date	15.02.2016
Drawer	RP	File	P6038-70 Adela Foundation.dwg

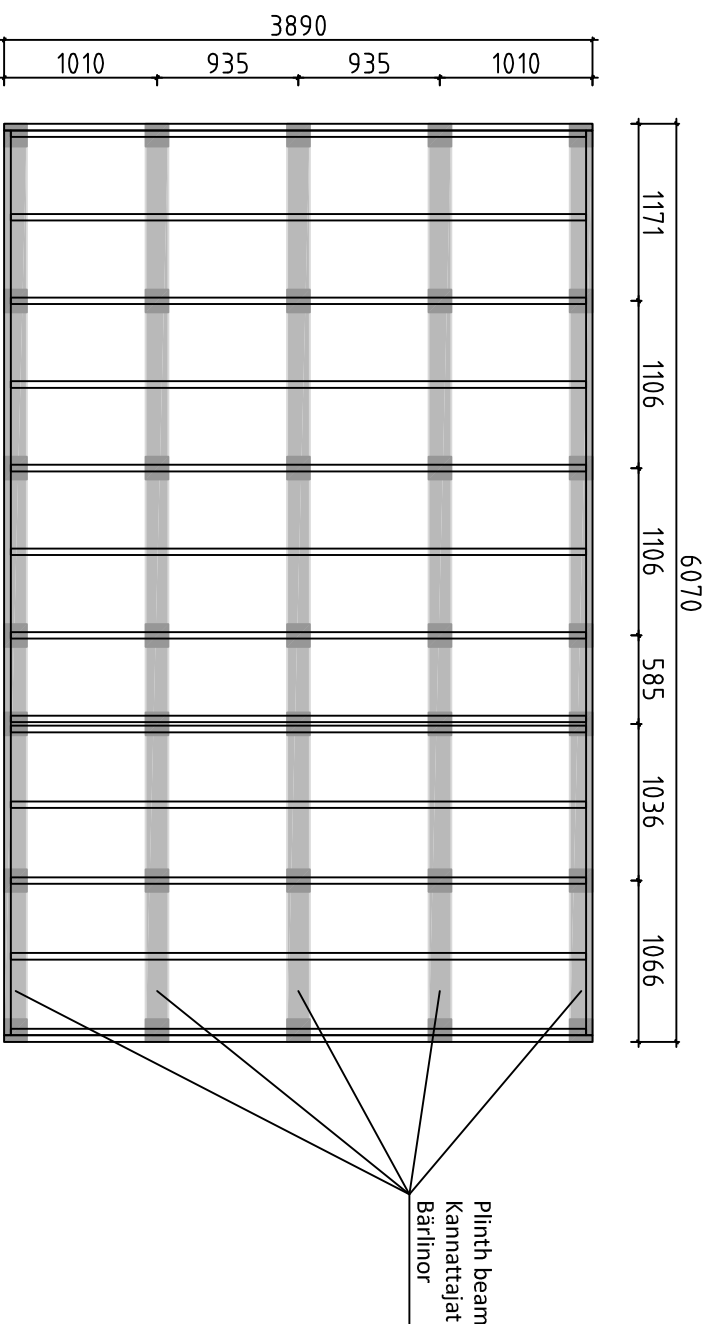

Förslag på alternativ plintplan med bärlnor och plintar. Bärlnor 45x 95 eller 45x 120 och plintar ca 100- 200 mm i diameter. (Bärlnor och plintar ingår ej i leveransen). Används exempelvis murblock, (ingår ej i leveransen) istället för plintar, kan man lägga bärlnorra platt mot dessa och på det sättet minska höjden på konstruktionen. I denna konstruktion kan man dessutom lägga en "boardskiva" mellan bärlnorra och golvbjälkarna och på det sättet bära upp bjälklagsisoleringen. Lagg fuktskyddande papp mellan betong och trä

Endotus valitoehtoista jalustasta kannattajilla ja jaloilla. Kannattajat 45x95 tai 45x120 ja jalat läpimitataan n. 100-200 mm (kannattaja ja jalkoja ei ole toimituksessa). Käytettäessä esimerkiksi harkkoja (ei kuulu toimitukseen) jalkojen sijasta, voi kannattajat asettaa lappeelleen niitä vasten ja sillä tavoin vähentää rakenteen korkeutta. Tässä rakenteessa voi lisäksi asettaa levyn kannattajien ja lattiapalkkien väliin ja sillä tavoin kannattaa alapohjan eristystä. Aseta betonin ja puun väliin kosteudelta suojaava pähvi

A proposal for alternative plinth beam layout plan. Plinth beams 45x95 or 45x120 and plinths ca 100-200 mm in diameter (plinth beams and plinths are not included in the kit). For example, by using masonry units (not included in the kit) instead of plinths, one can lay plinth beams flat against the masonry units and in that way reduce the height of the structure. In this construction one can also add "plywood board" between plinth beams. Place cardboard between the concrete and wood to protect from moisture

House	P6038-70 Adela	Sheet	19
Drawing	FOUNDATION PLAN - PLINTPLAN	Scale	1:50
Material		Date	15.02.2016
Drawer	RP	File	P6038-70 Adela Foundation.dwg

#001		6280	1
#002	1,3	6280	2
#003	1,3	6280	17
#004	3	6280	1
#005	1	6280	1
#006	C	4200	1
#007	A	4200	1
#008	C	4200	1
#009	A	4200	1
#010	C	4100	16
#011	B	4100	1
#012	A	4100	16
#013	B	4100	1
#014	B	4100	1
#015	A	3373	1
#016	C	3373	1
#017	B	2973	1
#018	1	2601	1
#019	1	2601	1
#020	2	2342	1
#021	2	2342	16
#022	2	2342	1
#023	B	1570	15
#024	A,C	1458	2
#025	1	1257	13
#026	B	1058	1
#027	1,3	805	2
#028	1,3	805	2
#029	2	705	1
#030	1,3	530	14
#031	2	530	2
#032	1,3	530	2
#033	1	529	1
#034	1	529	14
#035	1	529	13
#036	B	470	15
#037	2	367	1
#038	B	270	15